

INTEGRATED CONNECTOR MODULES

10/100Base-TX belMag™ with LEDs

BM00801

- Single port shielded RJ-45 connector with integrated 10/100 magnetics
- Compatible with a variety of 10/100 transceiver ICs
- Operating temperature 0° to +70° C
- Storage temperature -40° to +85° C
- Complies with IEEE standards and all 10/100 Ethernet specifications including 350µH with 8mA DC bias
- Integrated design conserves valuable board space
- Minimum interwinding breakdown voltage of 1500 Vrms
- Adaptable, modular design provides higher reliability
- Reduced pin count for improved crosstalk and optimum PCB trace routing

ELECTRICAL SPECIFICATIONS AT 25° C

Part Number	Insertion Loss dB max	Return Loss dB min				Common to Differential Mode Rejection dB min	Common to Common Mode Rejection dB min	Crosstalk dB min			
		1MHz to 100MHz	1MHz to 30MHz	30MHz to 60MHz	60MHz to 80MHz			100kHz to 100MHz	1MHz	30MHz	60MHz
0810-1XX1-01	-1.0	-18	18 - 20 log (f/30MHz)	-12	40	30	-65	-45	-37	-35	
0810-1XX1-02	-1.0	-18	18 - 20 log (f/30MHz)	-12	40	30	-65	-45	-37	-35	
0810-1XX1-03	-1.0	-18	18 - 20 log (f/30MHz)	-12	40	30	-65	-45	-37	-35	

SCHEMATICS

0810-1XX1-01
0810-1XX1-02

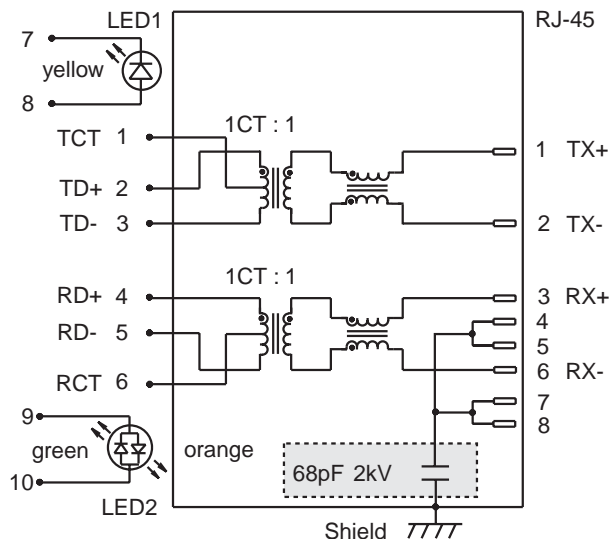

Included in 0810-1xx1-01 only.

0810-1XX1-03

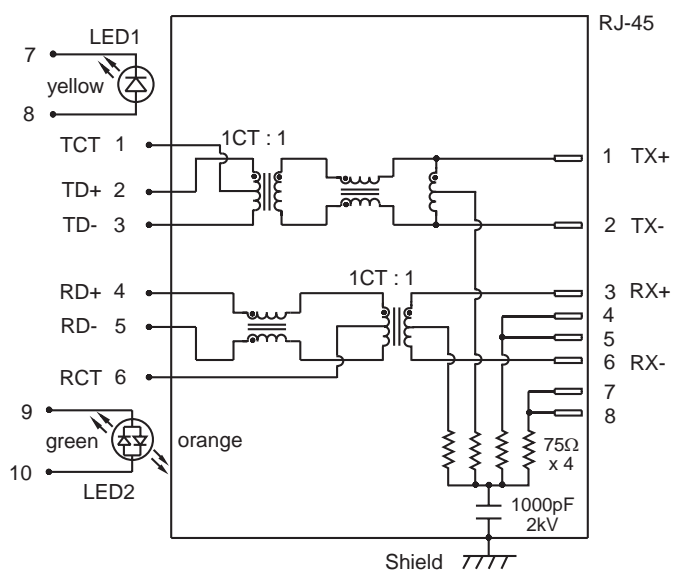

BM00801

MECHANICAL

0810-1XX1-01
0810-1XX1-02
0810-1XX1-03

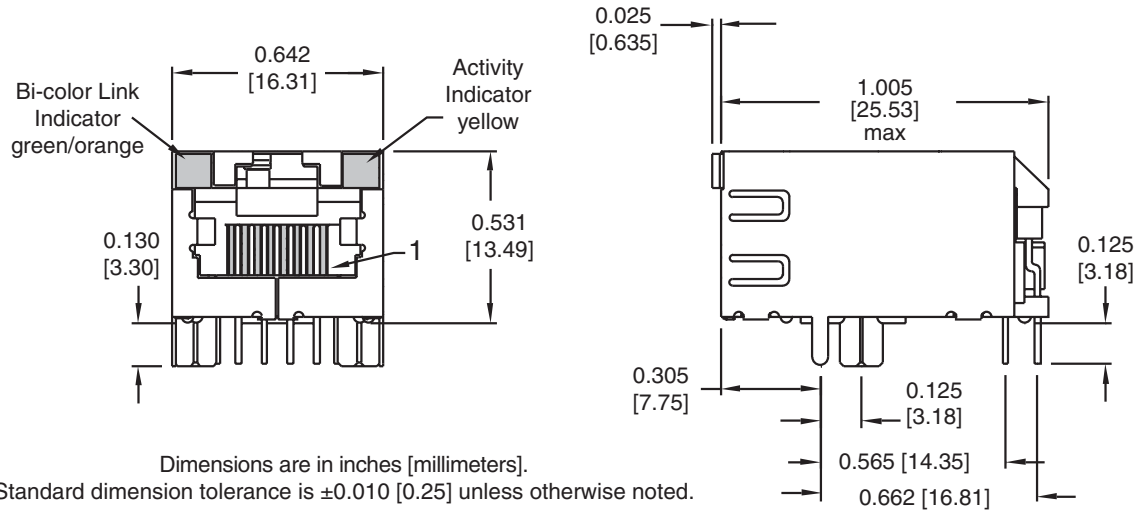

PAD LAYOUT

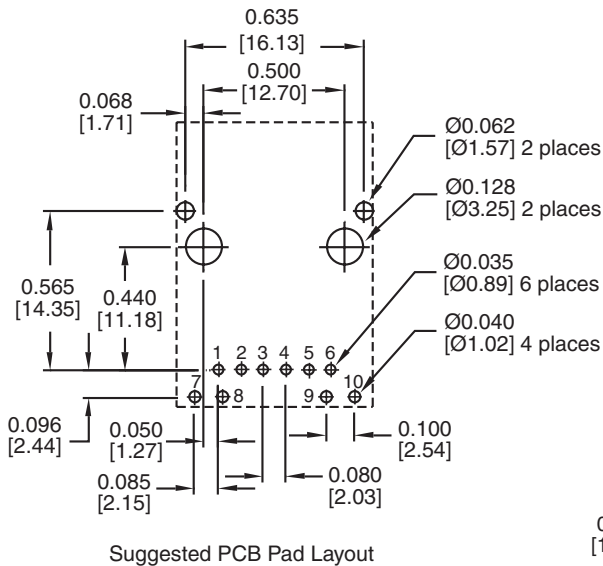

Notes

Plastic Housing	Thermoplastic, flammability rating UL 94V-0
Contacts	50 micro-inch hard gold plating
Pins	Tin-coated copper wire, DIA 0.018" [0.46]
Solderability	Per MIL Std. 202, Method 208
Metal Shield	Tin lead plated copper alloy

Available Options

- Various transformer turns ratios
- Various high voltage capacitor values
- Various LED color combinations

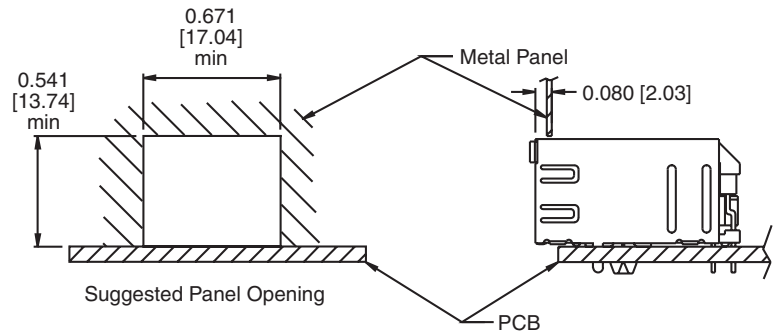

©2008 Bel Fuse Inc. Specifications subject to change without notice. 06.08

CORPORATE

Bel Fuse Inc.
206 Van Vorst Street
Jersey City, NJ 07302
Tel 201-432-0463
Fax 201-432-9542
www.belfuse.com

FAR EAST

Bel Fuse Ltd.
8F / 8 Luk Hop Street
San Po Kong
Kowloon, Hong Kong
Tel 852-2328-5515
Fax 852-2352-3706
www.belfuse.com

EUROPE

Bel Fuse Europe Ltd.
Preston Technology Management Centre
Marsh Lane, Suite G7, Preston
Lancashire, PR1 8UD, U.K.
Tel 44-1772-556601
Fax 44-1772-888366
www.belfuse.com